

MP1010 Multi-Purpose Load Bar

www.tru-test.com
 Tru-Test Limited, ISO 9001 Registered Company
 PO Box 51078 Pakuranga, Auckland 1730, New Zealand
 25 Carbine Rd, Mt Wellington, Phone +64 9 978 8888, Fax +64 9 978 8889
 e-mail service@trutest.co.nz

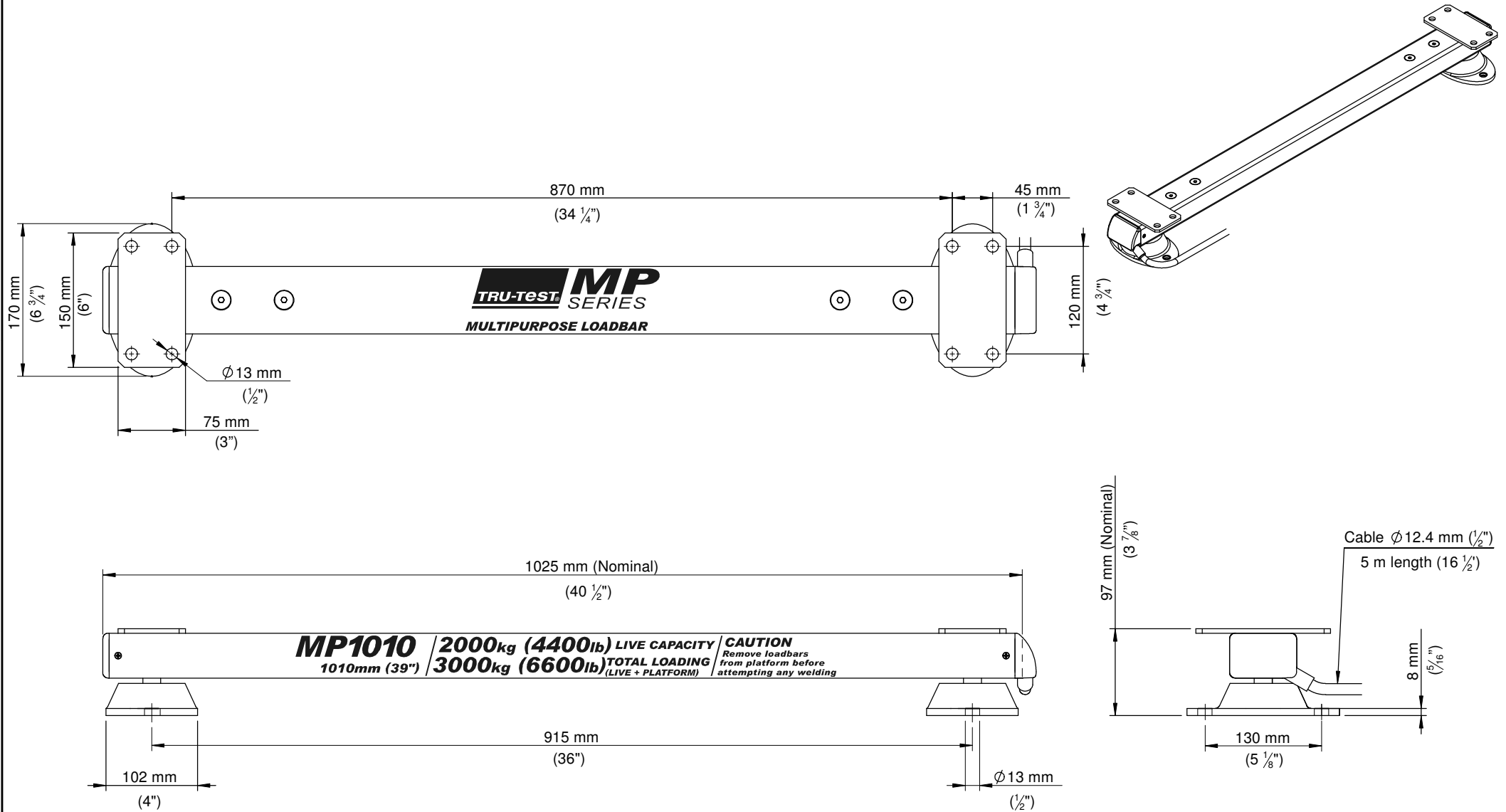

DRAWING NOT TO SCALE.

OUTLINE DRAWING FOR OVERALL PRODUCT DIMENSIONS AND MOUNTING CENTERS. ALL IMPERIAL DIMENSIONS ARE APPROXIMATE ONLY.

© Tru-Test Limited, 2006. All rights reserved. Associated patents and trademarks are the property of Tru-Test Corporation Limited.